

# Equilibrium

VOL 66 - JANUARY - DECEMBER 2022

## Heading Towards Self Reliance



CASE STUDY  
04-12

ENVIRONMENT  
13

CSR ACTIVITIES  
15

**AceMicromotic**  
Group

# CONTENTS

## Message

- 03** Kapil Dhand  
Managing Director, MGT
- 03** NK Dhand  
Chairman, MGT

## Case Study

- 04** Delphi-TVS  
When Small Is No Big Deal
- 05** Pragati Automation Pvt Ltd  
Focussed on Progress
- 06** RR Precision India  
Making Precision a Reality
- 07** Federal-Mogul Goetze (India) Ltd  
Helping Customers Grow
- 08** Bharat Forge Ltd  
Collaboration is Multiplication
- 09** Bharatiya Reserve Bank Note  
Mudran Public Ltd  
Meeting Customer Needs

- 10** Wipro Enterprises  
High Up in the Air
- 11** Berger Group  
Working Together is Success
- 12** Hero Motors  
Challenges Lead to Growth

## Environment

- 13** Nurturing the Nature

## CSR Activities

- 15** Giving Back To Society

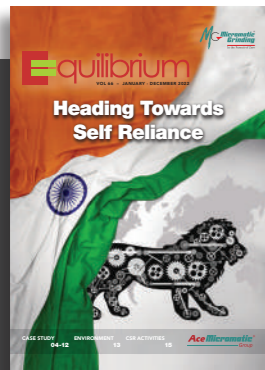

## Imprint

Published by  
Micromatic Grinding  
Technologies Pvt Ltd

Printed by  
Repromen Offset  
Printers Pvt Ltd,  
Bangalore

Content & Design:



## MESSAGE



**KAPIL DHAND**  
Managing Director  
Micromatic Grinding Technologies (MGT)  
[kdhand@micromaticgrinding.com](mailto:kdhand@micromaticgrinding.com)

## Achieving a Great Milestone

**B**y the end of the year 2022, MGT completes 50 years of its founding and will be celebrating its 50<sup>th</sup> anniversary next year. On this historic occasion, I want to offer my profound gratitude to the Almighty for his blessings, MGT's Employees who have carried the responsibility on their shoulders and carried us this far, our Suppliers and Stakeholders (Banks, Govt. Agencies) who have enabled us to succeed, and the society which has helped us not just to survive but also to thrive.

In a few months, India will surpass China to become the most populous nation in the world. For the prosperity of its growing youth population and to be able to leverage its demographic dividend, the country's manufacturing industry must grow many folds from its current 14 percent share of GDP.

Over the last 50 years, MGT has played an important role in improving the competitiveness of its customers through the successful development of many import substitute products. This issue of our magazine is a tribute to all those who enabled this mission. We have also compiled a few success stories to offer a sneak peek into the growth of those who contributed significantly to ours.

Evoking pride through what we do and impacting society by the way we do it, using precision engineering at the core, is MGT's vision for the future. Only this will enable self-reliance—AatmaNirbharta—is our underlying belief. We will continue this journey in the same spirit as we move beyond 50.

This message will be incomplete without paying heartfelt gratitude to our Chairman Shri NK Dhand, whose leadership has led us so far. It is under his tutelage that we MGTians continue to flourish. His passion and purpose energize us; his spirituality enlightens us. May his legacy continue to thrive through MGTians' past and present.

We, MGTians, are blessed to be part of the AceMicromatic Group, where our other founding fathers—Lt Shri Ashok Sathe, Shri SG Shirgurkar, Shri B Machado, Shri P Ramadas—continue to guide us to become better corporate citizens and grow together.

I wish all the readers a Very Happy and Prosperous New Year. My best wishes to you for your bright future.

Onwards and upwards together.



**NK DHAND**  
Chairman  
Micromatic Grinding Technologies (MGT)  
[nkdhand@micromaticgrinding.com](mailto:nkdhand@micromaticgrinding.com)

## Staying Mindful of Action and Intention

I echo Kapil's words of thanks and gratitude to all the forces of Bhagwan that came together, in uncountable, animate, and inanimate forms, to make Micromatic Grinding Technologies (MGT) achieve the milestone of completing these incredible 50 years. It feels surreal as neither of us—VS Goindi and myself—imagined coming this far when we started this journey in October 1972 with the naming of our enterprise as 'Micromatic Machines'.

People, as is customary, ask us how did we make it here. The answer, my friend, lies in the famous message of Lord Krishna to Arjuna in Bhagavadgita, chapter 2, shloka 47. We, at MGT, have just been focused solely on performing our duties relentlessly, but never to claim its fruit. We have always tried to maintain equanimity under all circumstances and intend to follow the same path in the future too.

कर्मण्येवाधिकारस्ते मा फलेषु कदाचन |  
मा कर्मफलहेतुर्भूर्मा ते सङ्गोऽस्त्वकर्मणि || 47 ||

**Translation:** Your right is to perform your duty, but never to claim its fruit. Never consider yourself to be the cause of the fruit of your actions, nor your attachment be for inaction.

# When Small Is No Big Deal

MGT customized its model e-Grind 200 to finish grind its old customer Delphi-TVS' 'Inlet Valve', a very light and small component, and help it achieve critical accuracies.

**E**STABLISHED in 1952, Delphi-TVS is a joint venture between **Delphi Corporation, USA**, one of the world's largest automotive systems Tier 1 supplier, and **TVS Group**, India's largest automotive systems Tier 1 supplier. Delphi-TVS offers state-of-the-art Diesel Fuel Injection Technology to all the major automotive manufacturers. The company is an old customer of MGT using more than 30 machines since the 1990s.

In the past, team MGT has developed many special grinding applications for Delphi-TVS, meeting many of their import-substitution requirements.

This time too, besides meeting the stringent

geometric and size tolerances, the size and weight of the component were very special. Delphi-TVS' component 'Inlet Valve' has been the lightest and probably the smallest component MGT has ever finish ground. It weighs only **0.96 gm, and is 13 mm in length and 3.24 mm dia.** The customer wanted a machine where the 2 seat angles, OD, and lead chamfer were all ground in a single plunge, thus achieving critical accuracies. A special program for accurate profile dressing of the grinding wheel was also developed to achieve these accuracies. MGT customized its model e-Grind 200 with robotic automation and palletized loading-unloading of the components to achieve the highest productivity.

### Critical Accuracies Achieved:

Size Tolerance:	0.002 mm
Roundness:	0.002 mm
Surface Finish:	0.3 Ra
Productivity:	20 seconds/part



Figure 1: e-Grind 200 with Automation



Figure 2: Robotic arm for loading and unloading of components



Figure 4: Weight of Component, 0.96 gm only

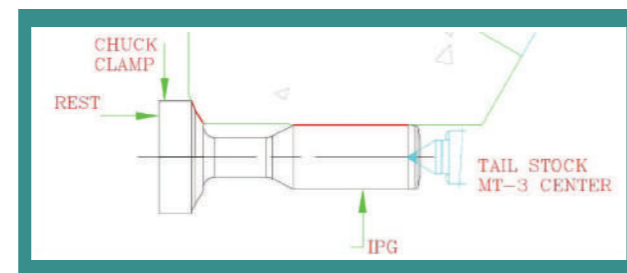

Figure 3: Grinding Layout

# Focussed on Progress

MGT's long-term associate Pragati Automation Pvt Ltd had some unique requirements which MGT met with a new product development named, 'TSG 300-2S'. It was a total win-win situation. It not only helped Pragati get what it wanted, it also aided in MGT foraying into a new segment of 'slot grinding' of chucks.

**P**RAGATI Automation Pvt Ltd (previously PEW-Pragati Engineering Works Pvt Ltd) was established in 1976 by the Late AV Sathe and PD Kulkarni. The company specializes in manufacturing critical sub-systems of CNC Turning i.e., Tool Turrets and Automatic Tool changers (ATC) for CNC Machining Centers, besides Power Chucking Cylinders, Index Tables, etc. It exports more than 50 percent of its products to overseas customers, mainly based in Germany, Poland & China.

Pragati and MGT have a more than 45 years long history of joint development of several grinding applications. In fact, the very first Cylindrical Grinder model GCU-100 that MGT built in 1977 was delivered to Pragati. Today, Pragati, with more than 30 MGT grinding machines, has three manufacturing plants and several other associates in India, besides the fourth plant in Shanghai, China.

This time, Pragati Automation came up with the requirement of grinding the T-slot and Jaw-slot of their new product—3-Jaw Chucks.



Figure 1: Jaw-slot grinding with horizontal grinding spindle



Figure 2: T-slot grinding with vertical grinding spindle

### CHALLENGES GALORE

- Pragati wanted a single set-up to grind both the T-Slot and the Jaw-Slot of the chuck for the close control of geometrical accuracies and consistency.
- Besides grinding, a crosshatch pattern had to be produced on the walls of the slots for better lubrication of the Jaws.

### MGT SOLUTIONS

MGT developed a whole new product/solution named 'TSG 300-2S' for this application.

- It consists of two grinding wheel spindles—one Vertical for T-Slot grinding and the other Horizontal wheel spindle for Jaw-slot grinding;
- CBN grinding wheels were selected in place of normal wheels for higher productivity;
- A special application program was developed for producing the crosshatch pattern in grinding;
- A critical fixture for holding the component/chuck was also developed in-house.

With this new product, MGT forayed into the new segment of slot grinding of chucks and now can cater to other chuck manufacturers. It can also cater to applications where vertical slot or horizontal slot grinding is required.



Figure 3: Machine TSG 300-2S

# Making Precision a Reality

MGT, with its Jaguar 6-Axis CNC Centerless Grinder (CLG 6030 TG), could precisely match RR Precision India's requirements for grinding components for the export market. This achievement has opened up a plethora of opportunities for MGT.

RR Precision India Pvt Ltd was founded in 2007 in Kolar, near Bangalore, with the vision to provide high-quality precision components globally. The company specializes in precision machining of Hydraulic Spools, Shafts, Valves, Pistons, Hydraulic assemblies, adaptors and fittings, Aerospace components. The company shipped nearly 8 million parts in 2020, using mostly imported machines.

RR Precision had a requirement of exporting hydraulic spools with critical geometrical accuracies on a Centerless Grinder. It approached MGT with its requirements.

### CHALLENGE

Before ordering the machine, the customer wanted MGT to prove critical accuracies on the component (spool). The customer had already tried it on an



Figure 1: Jaguar CLG 6030 TG



Figure 2: Component being fed by the conveyor for grinding.

imported machine (Micron, Japan). However, with the goal of promoting 'Make in India' concept, it decided to give an opportunity to an Indian manufacturer. Besides, MGT's price was nearly 50 percent of the cost of the imported machine.

### MGT'S SOLUTION

MGT used the existing model Jaguar 6-Axis CNC Centerless Grinder (CLG 6030 TG) tooled-up to grind the component. Team MGT not only achieved the geometrical accuracies matching the customer's requirements but also the productivity. This reaffirmed the customer's confidence in the company's product, tooling & process design, and application capabilities.

With this achievement, MGT can now cater to hydraulic spool and other high-precision export requirements of strategic sectors, which is a niche area, so far catered by high cost imported machines only, thus Promoting 'Make in India' and Achieving 'Atma Nirbhar Bharat'.

### Results achieved:

Size tolerance:	±1μ
Roundness:	1μ
Cylindricity:	2μ
Surface finish:	Ra 0.15



Figure 3: Finished component

# Helping Customers Grow

MGT developed a new TWIN GRIP 6-Axis CNC Centerless Grinder CLG-6050TG equipped with special features to meet its customer Federal-Mogul Goetze (India) Ltd's requirement for a high-production (10,000 parts/hr) grinding solution.

GOETZE (India) Ltd was established in 1954 as a joint venture between Goetze-Werke of Germany and Escorts Ltd of India. The parent company Goetze-Werke was later taken over by Federal-Mogul Corporation USA, a \$6.3 billion global company and the world's leading manufacturer of automotive components. Goetze (India) Ltd was later renamed as Federal-Mogul Goetze (India) Ltd. The company is a world-class manufacturer of pistons, piston rings, liners, etc. that cater to a wide range of applications in two/three-wheelers, cars, SUVs, tractors, etc.

Federal-Mogul is already using 4 machines from MGT. This time they wanted an indigenous grinding solution for OD grinding of 'Valve Guides'. There is a huge market requirement for 'Valve Guides', which the customer sells to domestic and export markets. Federal-Mogul approached MGT for a grinding solution that could produce (10,000 parts/hr or at 6000 mm/min thru feed) and prove the critical

accuracies. MGT developed a New TWIN GRIP 6-Axis CNC Centerless Grinder 'CLG-6050TG', equipped with the listed-below special features.

- Grinding wheel size OD 610 x width 500 mm/45 kw power for high material removal in a single pass;
- Rotary bowl feeder system for feeding large volume parts at high speed;
- Post-process inspection (non-contact type) integrated with the machine CNC for auto-size-compensation;
- Cpk and the average size are continuously displayed for quality monitoring on the machine as well as on the remote PC connected with the LAN;
- Output parts conveyor system was designed with thru feed rate of 6000 mm/min. This resulted in achieving target productivity besides critical accuracies.

With this new product, MGT now can cater to similar applications where highest productivity, besides the critical accuracies are required.

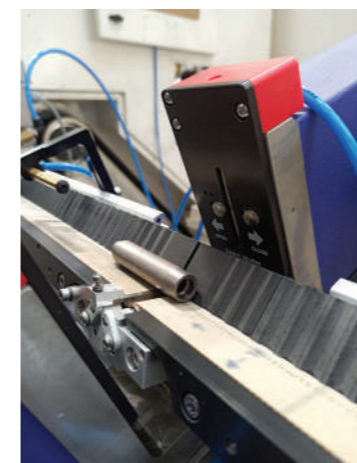

Figure 1: Post process inspection of component



Figure 2: Rotary bowl for feeding components



Figure 3: 6-Axis, CNC Centreless Grinding Machine, Twin Grip, CLG-6050TG

### Achievements:

Thru feed rate:	6000 mm/min, achieving cycle time of 0.3 sec/part
Roundness:	< 1.5 μ
Taper:	< 1.0 μ
Cpk:	>1.67



Figure 4: Finished component

# Collaboration is Multiplication

MGT Team took on the challenge to design, develop and deliver an entirely new product—a high-tech import substitute product 'Twin Head CBN Grinder'—for Bharat Forge Ltd. The requirement was not only to meet and exceed technical and economic output but also to urgently deliver the machine so that BFL could keep its commitment to its customer.

**INCORPORATED** in 1961, Bharat Forge Ltd (BFL) is an Indian multinational company involved in forgings for Automotive, Energy, Construction and Mining, Railways, Marine, Aerospace, and Defense industries. The company is also India's leading manufacturer of Crankshafts for these and several other sectors. Currently, BFL is the 'world's largest single-location forging facility', consisting of fully automated forging press lines and state-of-the-art machining facilities.

MGT has a long association with BFL's indigenization program of this critical finish grinding operations of Journals of these Crankshafts. It all started with the development of the first machine model Rhino R-120 in 2010-11, with an Alox wheel and a speed of 60 mps, for journal grinding of six-cylinder crankshafts. Supported by BFL, MGT went on to develop the CBN Journal Grinder in the year 2017, with a wheel speed of 80 mps for a 4-cylinder crankshaft. After having a satisfactory experience of procuring 17 units of R-120 and 3 units of CBN Journal Grinder from MGT, last year BFL again approached the former for a new machine with a Twin CBN Wheel head for journal grinding of the six-Cylinder Crankshaft.

## CHALLENGES

- Six-cylinder crankshaft grinding time for all journals to be  $\leq 8$  min;

- Crowning of 4 micron was an important new feature required in the journal. This is generated on the wheel by the linear axis interpolation of the dresser carrying slides. The challenge was to generate 4 micron crowning profile with consistency and smoothness;
- Radius merging must also be in the range of specifications (80-85 deg).

## APPROACH

MGT adopted a collaborative approach not only with the customer BFL who supported on all the technical details but also with all the other stakeholders, including In-Process Gauge manufacturer Balancing System, Chuck manufacturer SMW, Dressing Spindle and Disc Dresser supplier besides Coolant System supplier Udly. This helped MGT meet all the technical requirements of the customer and exceed their expectations.

## Specifications:

Size variation:	$\leq 0.020$ mm
Roundness:	$\leq 0.005$ mm
Taper:	$\leq 0.005$ mm
Ovality:	$\leq 0.008$ mm
Cylindricity:	$\leq 0.010$ mm
Straightness:	$\leq 0.005$ mm
Crowning:	0.004 mm
Cycle time:	8.5 min (1.25 min/journal)

Sl. No.	Machine	Year of Development	M/C Speed (mps)	Component	Cycle Time (min)	Average Cycle Time / Journal (min)	No. of Machines Supplied
1.	Rhino R120	2010-11	60	6-Cylinder Crankshaft	19	2.7	25
2.	CBN Journal Grinder	2017-18	80	4-Cylinder Crankshaft	10	2.0	8
3.	Twin Head CBN Journal Grinder	2021 & 22	80	6-Cylinder Crankshaft	8.5	1.25	2

Table 1: Crankshaft Journal Grinding solution development timeline

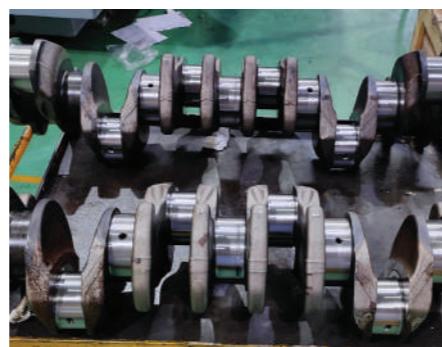

Component "Six-cylinder crankshaft"

# Meeting Customer Needs

Bharatiya Reserve Bank Note Mudran Public Ltd opted for MGT's Cylindrical Grinding Machines over the imported ones it had been using as they matched the company's requirements to a tee and were also cost-effective.

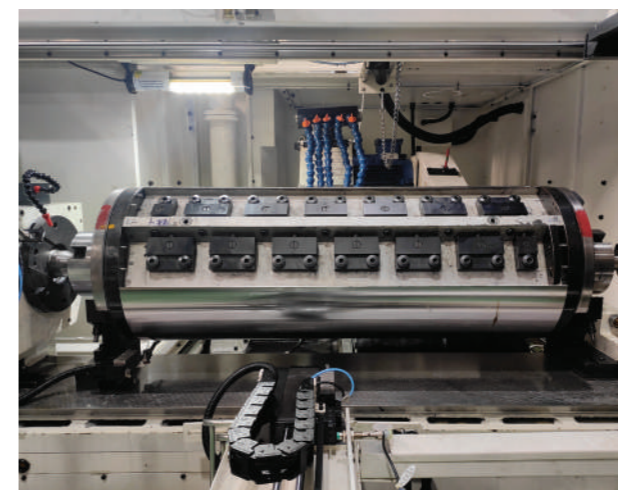

Special design Mandrel to enable the Nickel sheet to be mounted

**BHARATIYA** Reserve Bank Note Mudran Public Ltd (RBI) required a Cylindrical Grinding Machine for grinding Nickel plates of 900mm width and 1000mm length. S Rajesh from the MMT marketing team headed to RBI Mysuru to get a first-hand understanding of the application and the process. Based on his understanding, he sent a PDF document giving the full details of the machine and the grinding process.

RBI needed to grind the nickel plate, which is a part of the printing machine roll that prints the 1000 mm wide currency sheet rolls continuously. The company has a special process to emboss currency impressions on the plate by electroplating. This electroplating process leaves uneven surfaces on the back of the

nickel plate. To make the surface of the plate even, a grinding operation is required so that there are no defects on the currency notes while printing.

## MGT MACHINE WINS

RBI had been using 30-year-old imported hydraulic grinders that were still working but not without breakdowns and other related issues common on such old machines. In the spirit of 'AatmaNirbhar Bharat', the company decided to go for an Indian-make machine this time. It released an open tender and shortlisted three to four offers, of which MGT's solution was the most cost-effective. Besides, it matched their technical requirements completely. MGT got the order for two machines—one from their Press in Salboni, West Bengal, and another from the Press in Mysore, Karnataka. NS Verma (Chief Technical Advisor) and Vipin Pal (Sr. Manager, DDM) visited RBI Press to understand the process better.

Things that made this case special:

- The Mandrel on which the nickel plate is clamped and ground;
- In-process gauges (to control plate thickness within  $\pm 0.005$ mm);
- Grinding process to get desired accuracies and surface finish.

The key was to design and manufacture the Mandrel precisely, on which the final accuracy of the plate depended. MGTians are proud to have accomplished one more task in the nation's service.



Mandrel with the printing sheet mounted, ready for grinding



(L to R): C Annadorai, AGM, Mysore Press; Venkataswamy, Asst Manager, Mysore Press; NS Verma, Chief Technical Advisor, MGT and Vinod Kumar, Senior Engineer, Applications, MGT

# High Up in the Air

MGT modified its OD Grinding machine model Stallion SM-120 to meet its client's special requirements and can now provide critical solutions for a diverse range of aerospace components.

**W**IPRO Enterprises has Wipro Consumer Care and Lighting and Wipro Infrastructure Engineering (WIN) under its umbrella. WIN, today, is a diversified business in Aerospace, Additive Manufacturing, Automation Solutions, and Water Treatment. Established in 2013, the Aerospace business provides solutions in Actuators (Cylinders and Pistons), Aerostructures, Machining, Sheet Metal, Assembly, and Testing.

### GETTING THE CUSTOMER'S REQUIREMENTS RIGHT

WIN had a requirement for a grinding machine for grinding 2 Aerospace components. These components are part of the landing gear assembly of airplanes. The first component axle, 1,257 mm in length, required OD grinding and the second component axle sleeve, required ID grinding with a bore length of up to 375 mm.

Since the customer wanted both OD and ID grinding on one machine, MGT modified its OD Grinding machine model Stallion SM-120 into a universal configuration having both an External Wheel

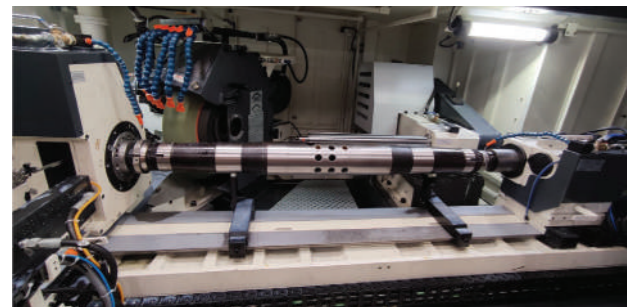

Figure 1: OD Grinding Set-Up

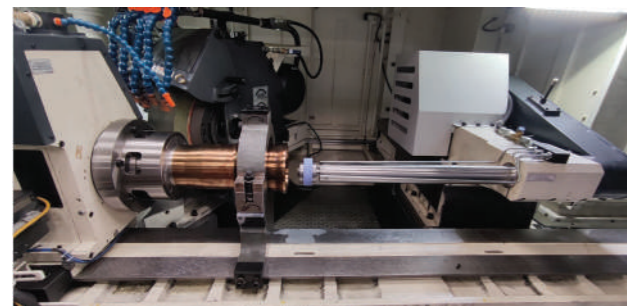

Figure 3: ID Grinding Set-Up

**Head and an Internal Wheel Head.** This resulted in cost savings as well as saving of the shopfloor space for the customer. For ease of operation, a custom screen was also developed.

OD grinding was done in 12 plunges with Traverse (See Fig 2), and Bore Grinding was done at 3 different IDs (see Fig 4). With this application, MGT can now provide critical solutions for a diverse range of aerospace components, which is yet another step towards an AatmaNirbhar Bharat.

### OD Grinding Results:

Components Name:	Axle
Ovality:	< 7 μ
Roundness:	< 3 μ
Diameter tolerance:	Asked: ± 35 μ Achieved: < 15 μ

### ID Grinding Results:

Components Name:	Axle Sleeve
Ovality:	< 15 μ
Diameter tolerance:	Asked: ± 30 μ Achieved: < 15 μ

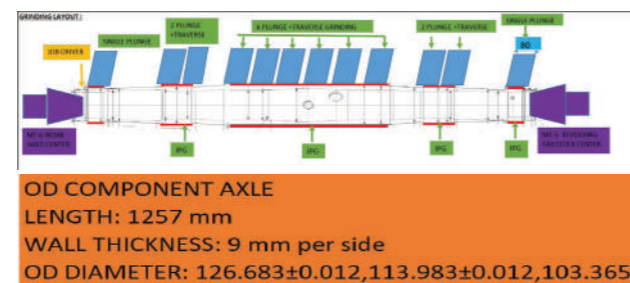

Figure 2: OD Grinding Layout

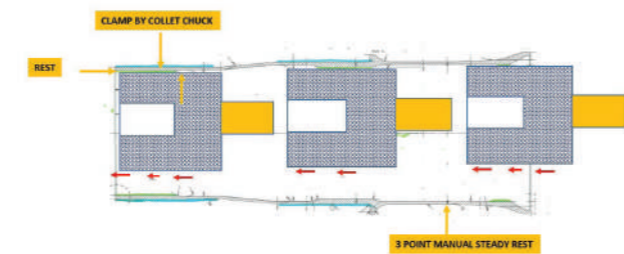

Figure 4: ID Grinding Layout

# Working Together is Success

In a collaborative project with Berger Group, MGT developed a complete automation system for the loading/unloading of the component, which, while being reliable and economic also reduced operator fatigue and improved uptime.

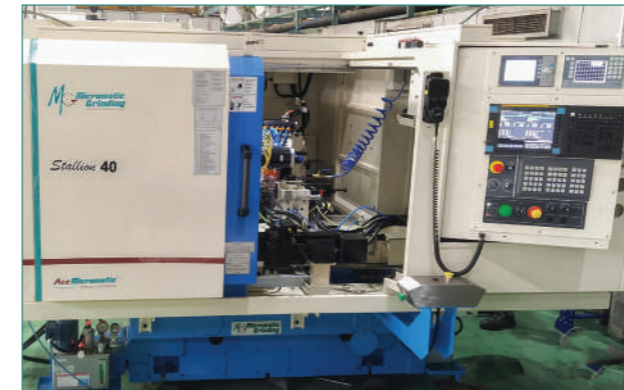

Figure 1: Stallion SM-40

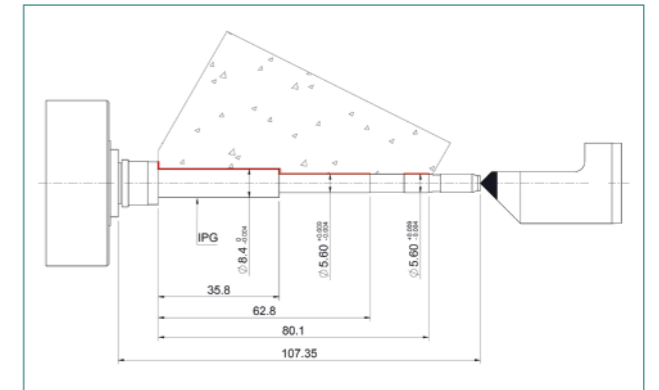

Figure 2: Grinding Layout of Component on SM-40

**E**STABLISHED in 1955 in Germany, Berger Group has been supplying companies around the world with ready-to-install high-precision, complex components. It has been the largest supplier of components to BOSCH worldwide. The Group is present at 11 locations in five countries i.e., Germany, Poland, Canada, USA, and China which combined produce nearly 2 million parts per day.

Berger has been a customer of MGT for over 10 years, having more than 10 machines. This time, Berger had the requirement of two Grinding machines with Automation for its Germany and Poland plant. This was a collaborative project with Berger, where the Group provided a reference for certain critical tooling for the loading/unloading of the component based on which MGT developed a complete automation system.

### CHALLENGES

- Berger part 'Shaft' was of slender shape and size, having thin sections ø5.6x44 mm, ø8.5x35 mm and a total part length of approx. 107 mm.
- Very high size accuracy e.g., ø8.5-0.004 was desired. Cylindricity requirement was ≤0.003 mm.
- Such parts having low cycle time (floor-to-floor

24 sec) required reliable gantry automation systems for the loading/unloading job.

### MGT SOLUTION

- MGT model Stallion SM-40 for two components and model E Grind 200 for three components were selected as the best fit for the customer application;
- Both machines were equipped with MGT-designed gantry automation to meet high-production requirements;
- MGT provided special tooling like Chuck and steady and low-pressure Tailstock to achieve not only the required technical output but also the desired productivity;
- Customer components were successfully proven out for all the size tolerances and GD&T within the target cycle time;
- The machines were exported after assessing and validating for 72 hr continuous run test to ensure complete reliability of the machines and automation system.

### BENEFITS

- A reliable and economic solution was provided to the customer;
- Automation for loading/unloading reduces operator fatigue and improves uptime.

# Challenges Lead to Growth

Taking up new challenges has always been in MGT's DNA. The company does not just overcome them but turns them into opportunities for its growth. Here's citing an example of its core value that came to the fore while fulfilling Hero Motors' special needs...

**ESTABLISHED** in 1998, Hero Motors specializes in end-to-end gear manufacturing and transmissions for high-end motorcycles and ATVs manufacturers like Ducati, BMW, and Harley-Davidson. It has two plants – in Dadri, UP and Mangli, Ludhiana, Punjab – with production capabilities reaching up to 100,000 small engines/transmissions per year. Hero Motors is already using MGT's four grinding machines and two machines are on order.

## 1<sup>ST</sup> CHALLENGE – ENSURING NO MARK

One of the machines is for a special requirement i.e., to produce a mark-free component in finish grinding for a high-performance motorbike. To meet the requirement, a special expanding mandrel was selected to ensure no mark is left on the job during clamping-declamping at the bore. Special contact-points were also selected for the

in-process gauge to eliminate any possible mark on the ground OD's, during in-process measurement of OD grinding.

## 2<sup>ND</sup> CHALLENGE – PROVIDING CONSISTENT OUTPUT QUALITY (OVALITY ≤ 0.005 MM)

This was difficult to achieve as the component was slender along the length, with only 3.23 mm wall thickness for a 60.02 mm OD tube and the grinding length being 17.5 mm from the tailstock end (see fig 4). The total length of the tube was 164.5 mm. where 3 sections of various thicknesses were ground with 2 sets of wheels, LHS and RHS, mounted on the same in-built servo motor. Special tooling was provided in-line to support the job from the inside bore and soft axial support by a special tail stock with the live center, minimizing any risk of increasing ovality during grinding.

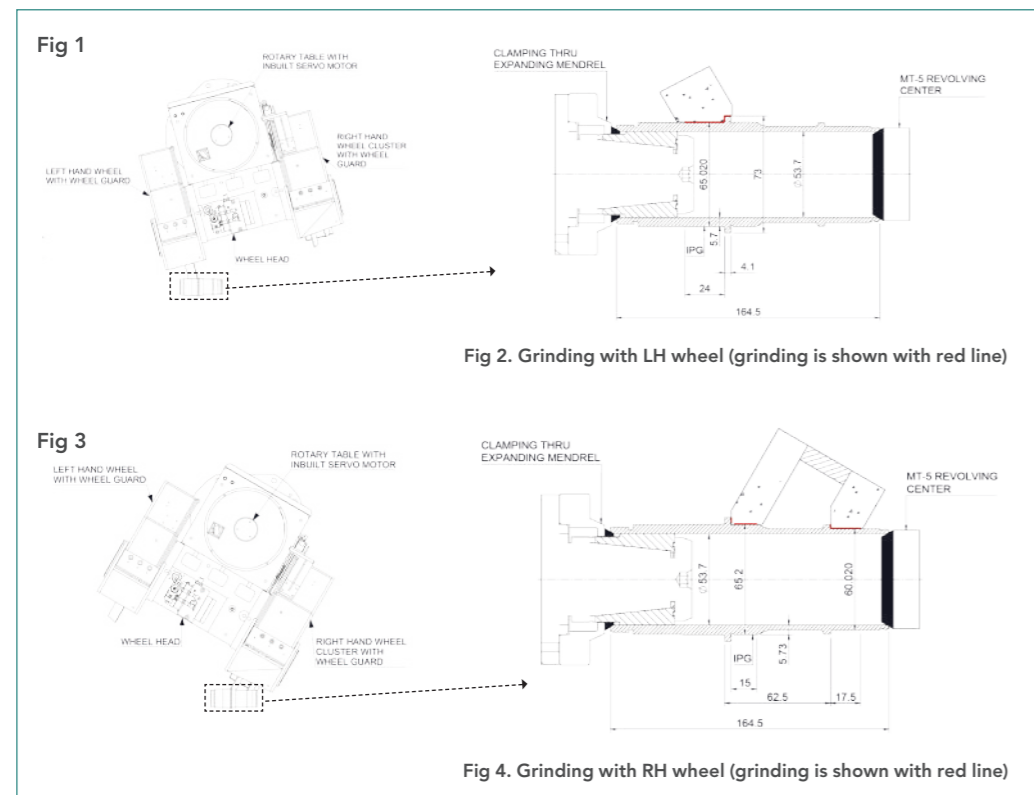

NOTE: Fig 1 and 2 are the Top view of the B-axis on Flexi-400, with a single In-built Wheel Head Spindle, allowing one wheel on the LHS of the spindle nose and a twin wheel pack on the RHS nose. This allowed one machine and only one set-up to perform all the grinding operations i.e., 4 dia. and 3 shoulders (see Fig. 2 and 4) in one setting. For more details on MGT's Model Flexi Universal Grinder, see the back page, no.16, of this issue.

## 3<sup>RD</sup> CHALLENGE – INCREASING PRODUCTIVITY

Currently, Hero Motors is using two machines for the existing process, in two separate settings which itself cannot provide the best ovality, best cycle time, or best output quality parameters. Besides, it takes 2X extra space, and an extra operator, consumables, etc. MGT suggested Flexi-400 (CNC Universal Grinding Machine) that can grind using

different wheels on either end of the same in-built servo spindle, in a single setup. Flexi machine enabled entire part grinding completed in the same set-up, eliminating any extra set-up time, to improve not only Quality but Total productivity, OEE. Eliminating another operator for the second machine, space, utilities, and consumables, etc. reduces the cost per piece ground by more than 50 percent for sure.

### Advantages of Flexi-400 CNC Machine

- Quality improved by 100%;
- Cycle time reduced by 50% by performing all grinding operations in one set-up;
- Total cost per piece (grinding) was also, therefore, reduced by > 50% by using one Flexi-400 instead of two CNC grinders.

## ENVIRONMENT

# Nurturing the Nature

Given its commitment to improving the quality of people's life, MGT has been working on projects that ensure environmental sustainability and economic use of valuable resources that we so essentially need to exist.

MGT has been working on the environment within and outside the plant in various areas for several years now. A report on the progress is given here by RK Mahajan, our 30 years veteran COO, who has made our vision—'In Harmony with the Environment & Society'—his personal mission.

### RENEWABLE ENERGY

MGT is working towards promoting renewable energy in our plant and in other industries where

we have influence. In our Ghaziabad plant, around 40 percent of energy is being used from the solar plant of 400 kW. We are also planning a solar plant of 250 kW in our Bangalore plant.

### Renewable Energy Dashboard

Year	2020	2021	2022
Total Energy used from Solar in kWh	0	76,286	3,75,000
Total CO <sub>2</sub> equivalent saved in tonne	0	120	350
Cost saving in lakh estimated	0	12	35

### WATER CONSERVATION

- We are conserving water by monitoring our main source of water from the borewell with real-time data such as water usage and groundwater depth through IoT.



RK Mahajan  
COO  
Micromatic Grinding Technologies



Two underground RWH units with two lakhs litres storage capacity

- We harness rainwater through two Rain Water Harvesting (RWH) units in Ghaziabad. The units have the capacity to store two lakh litre of water. We are presently harnessing around 40 lakh litre of water and charging the groundwater aquifer.
- MGT recycles water using a Sewage Treatment Plant with a capacity of 20,000 litre per day. All our water needs for gardening and sprinkling on the road is being used from the STP only.



Sewage Treatment Plant

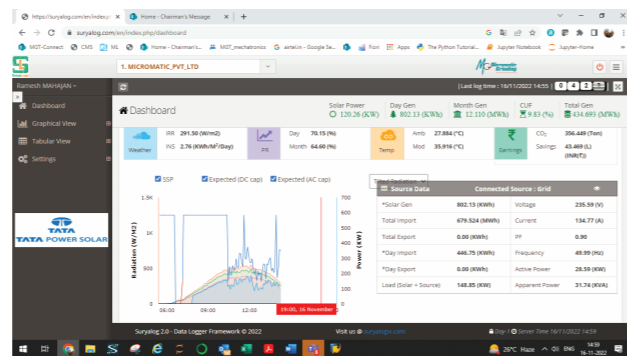

Solar power plant dashboard

**Water Conservation Dashboard**

Year	2020	2021	2022	
Water saved in RWH in litre	30,00,000	30,00,000	40,00,000	Estimated as per rainfall
Daily water consumption in litre	55,000	40,000	25,000	Online monitoring of data
Treated water in STP in litre	9,00,000	12,00,000	14,60,000	

**AIR POLLUTION AND DE-CARBONIZATION**

- We promote solar power for electricity. This way, part of our power requirements are covered by a method which does not contribute towards air pollution (As the Grid energy is mostly generated by coal).
- MGT has moved from Diesel to PNG (Piped Natural Gas) for most of our requirements. For example, we have replaced diesel burners for paint booths and diesel gensets with PNG as it is the cleanest form of fossil fuel.
- We encourage people to use cycle for commuting if they are residing in nearby areas.
- We are suggesting our employees to opt for carpools or use electric vehicles.
- We ask our vendors to choose renewables.

**De-carbonization Dashboard**

Year	2020	2021	2022	
Consumption of diesel per years in litre	48,000	25,000	22,000	
CO <sub>2</sub> equivalent saved in tonne	0	158	280	Due to reduction in diesel and solar power.
Equivalent No. of trees (Estimated)	0	6,320	11,200	One tonne of CO <sub>2</sub> saved is equal to carbon sequestration by 40 trees

**CIRCULAR ECONOMY**

We, at MGT, promote circular economy by:

- Using reusable/recyclable materials in our machines at the end of the life of a product;
- Recycling e-waste generated in our plant;
- Recycling water used in our plant;
- Undertaking the reconditioning of our machines to give them a new lease of life.

# Giving Back To Society

MGT has always acknowledged the contribution of the communities surrounding it in its success and looks out for all opportunities to serve them. Listed below are a few initiatives the company has taken together with Gram Niyojan Kendra in making a difference in their lives.



Meeting with Adolescent Girls



Meeting with Mothers

**S**TARTED in 1977, Gram Niyojan Kendra (GNK) is a national-level NGO, working towards transforming the lives of women and children from disadvantaged and deprived communities. [www.gromniyojan.org](http://www.gromniyojan.org). Since 1995, MGT has been associated with GNK, contributing to the development of communities around Ghaziabad. It supports and collaborates with the NGO for the education and health of Children and Women empowerment in nearby Rurban (Rural-Urban) areas. MGT believes these are important steps that contribute significantly to achieving an important part of MGT's Vision of 'progressing while being in harmony with the Society and the Environment'. Currently, MGT supports the following activities undertaken by GNK, covering three villages—Bapudham, Kanwani, and Nandgram—near Ghaziabad.



Education to Children



Dry Nutrition to Children

**AWARENESS GENERATION**

- 1,500 families in the three villages have been encouraged to vaccinate themselves and build immunity against COVID-19;
- MGT has been actively involved in spreading awareness among the community people, particularly women, on the importance of education of children, skill development and self-employment, Government schemes and programs, and domestic violence;
- 808 children have been immunized as per the routine and Government norms;
- 198 pregnant women have been provided TT injection, along with other support, in addition to counseling for routine check-ups in the hospital and institutional delivery to save themselves from any risks;
- 80 adolescent girls have been sensitized to menstrual health, nutrition, and hygiene management.

**EDUCATION TO CHILDREN**

- 125 children aged 3 to 6 years in three Balwadi centers are provided education in the play-way method;
- Children are provided dry nutrition like roasted gram, gursev, namkeen sev, murmure, and roasted moongfali dana on a regular basis;
- Growth monitoring is done at regular intervals using the MUAC method;
- Feedback is given to mothers on the progress of their children;
- Training is provided to the Balwadi center workers on the development of children and the teaching and learning materials they should be prepared with.

**ENVIRONMENTAL SANITATION**

- Recently, 8 camps were held covering 142 community women. The issues covered included: the importance of environmental sanitation, the impact of the environment on human life, the role of people in the protection of environment pollution, less use of polythene, solid and liquid waste disposal, cleanliness of surroundings, etc.



UNIVERSAL GRINDING MACHINES



- Flexi Series of grinders are CNC Universal Grinding Machines suitable for grinding of OD, ID and Shoulders in a single chucking.
- These machines are suitable for individual to large batch production, providing the highest level of Flexibility & Precision of size and geometry
- **EASE GRIND** software for flexibility in operation and use
- Operator friendly customized screens
- Easy changeover, with quick setting provision

### ALL OPERATIONS IN SINGLE CHUCKING

OD & Shoulder Grinding

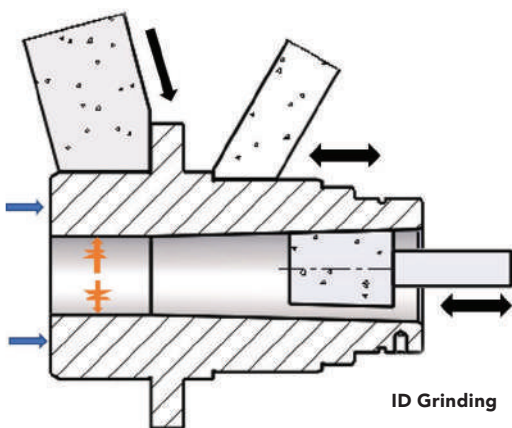

### TURRET WHEEL HEAD OPTIONS

Internal Wheel Head

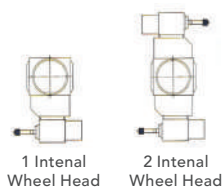

External Wheel Head

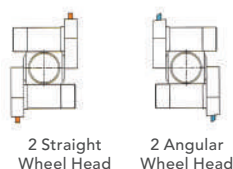

Universal Wheel Head

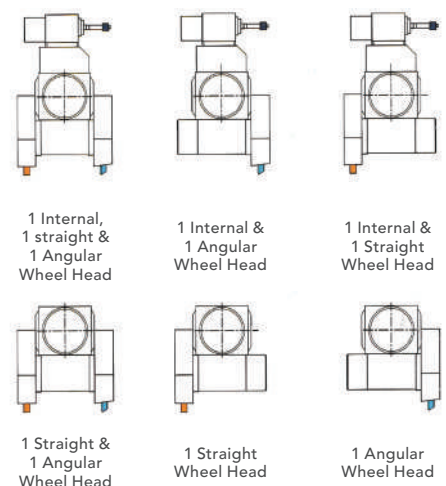

**Head office & North India Plant**  
**Micromatic Grinding Technologies Pvt. Ltd.**  
 C-27 & 28, Industrial Area,  
 Meerut Road,  
 Ghaziabad, (U.P.) - 201 003, India  
 Phones : +91-120-2712137, 69  
 E: sales@micromaticgrinding.com

**Bengaluru – South India Plant**  
**Micromatic Grinding Technologies Pvt. Ltd.**  
 Plot No. 5/A, Survey No.74,103,106,107  
 KIADB Dobaspet I Phase Industrial Area, Sompura Village,  
 Nelamangala Taluk, Bangalore District – 562 111. Karnataka, India  
 Phone : +91-80-27735384  
 E: sales@micromaticgrinding.com